

Varenummer: 03555040

Beskrivelse: Fluro hydraulik ledhoved FS 40C

Mål

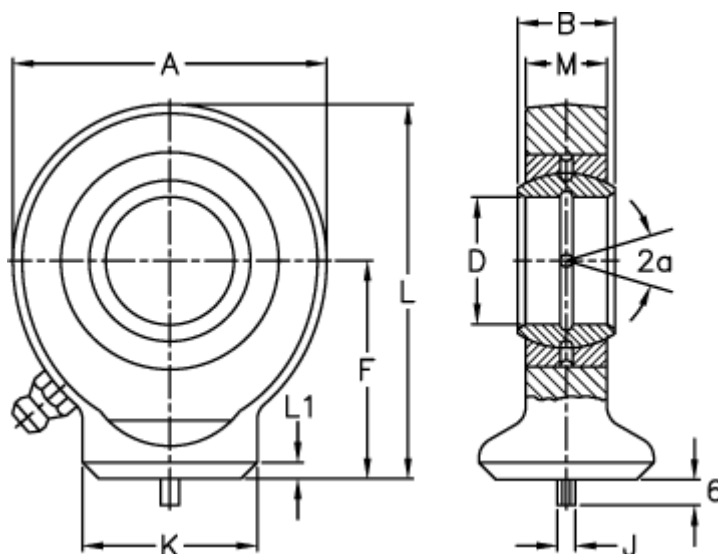

A	= 92	L	= 115
a (grader)	= 7	L1	= 5
B	= 28	M	= 23
D	= 40	Statisk belastning C0 (kN)	= 156
Dynamisk belastning C (kN)	= 100	Vægt	= 1400
F	= 69		
J	= 4		
K	= 52		